



**BOUWEN**

**WONEN**

**INTERIEUR**

**VMBO KB/BB**

# BIJ HET BEROEPSGERICHT PROGRAMMA BWI HOREN:

- Buitenschools leren/Projecten
- Stage
- LOB-opdrachten
- Examentraining



# LEERJAAR 3

4 Verplichte profiel delen

PROFIEL DELEN

Design &  
decoratie

Bouwen  
vanaf de  
fundering

Bouw-proces

Meubel  
verbindingen



# 4 profielmodulen

4 cijfers voor de profieldelen, die in leerjaar 3 worden afgesloten met een afsluitende opdracht (eindopdracht).

- CSPE (praktijkexamen), april 2021 resulteert in 1 cijfer
- Examencijfer is gemiddelde van cijfer profieldelen en CSPE cijfer

DECORATIEF SCHILDERWERK

# DESIGN & DECORATIE





# BOUWEN VANAF DE FUNDERING



# WERKEN ALS TIMMERMAN



# BOUWPROCES VAN TEKENING NAAR WONING

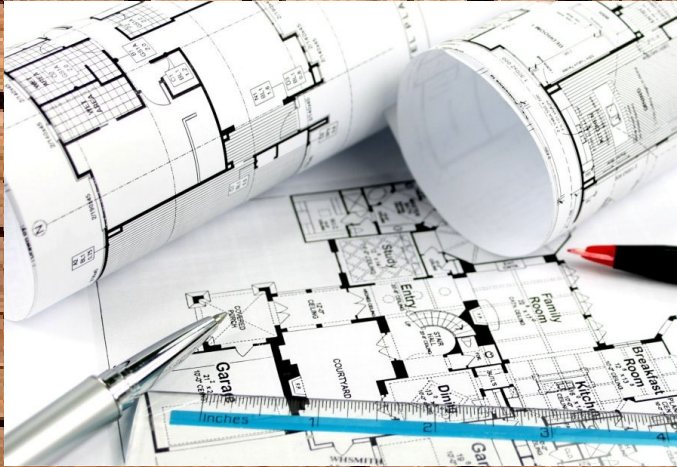



# MEUBELVERBINDUNGEN





# MEUBELVERBINDUNGEN

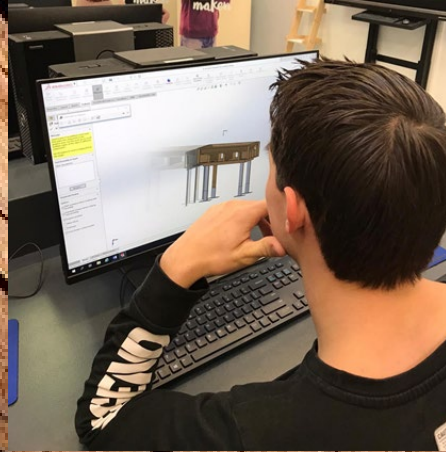

CNC

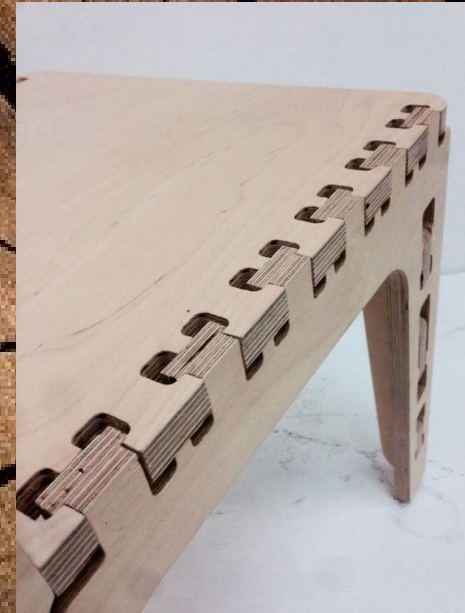

# Wanneer Profiel- en wanneer keuzedelen

## LEERJAAR 3

4 verplichte profieldelen

PROFIEL

Design en decoratie	Bouwen vanaf fundering
Bouw-proces	Meubel verbindingen

## LEERJAAR 4

4 vrije keuzedelen

KEUZEDLEN

Afwerkings-technieken	Interieur/meubel
Design	Timmeren





# KEUZEDEEL

INTERIEURBOUW/ DESIGN

# INTERIEURONTWERP EN DESIGN

**BOUW**  
**WONEN**  
**INTERIEUR**



## KEUZEDEEL

INTERIEURBOUW/ DESIGN (KEUZEDEEL UIT DIENSTVERLENING & PRODUCTEN)

# PRODUCT MAKEN EN VERBETEREN (NIEUW)

**BOUW**  
**WONEN**  
**INTERIEUR**





# KEUZEDEEL

INTERIEURBOUW/ DESIGN

# WONEN EN DESIGN (NIEUW)







# KEUZEDEEL

KEUZEDEEL INTERIEURBOUW/ DESIGN

# STANDBOUW EN BETIMMERINGEN (NIEUW)

**BOUW**  
**WONEN**  
INTERIEUR



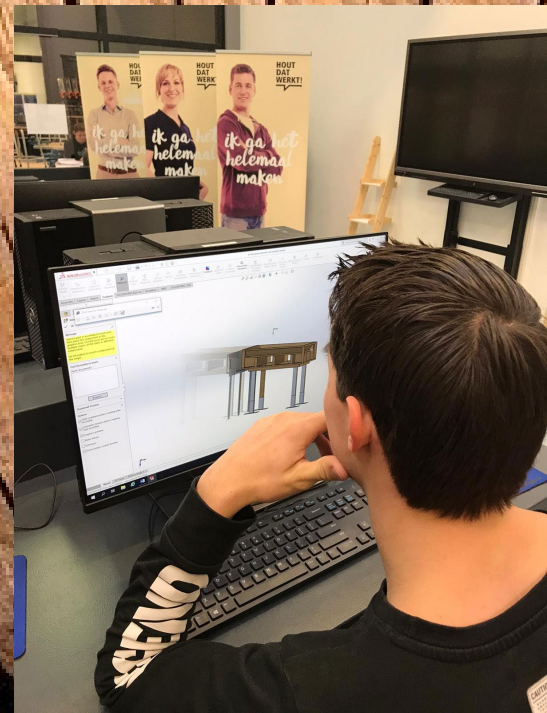
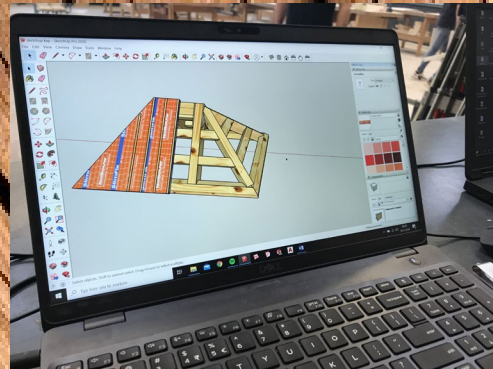

# KEUZEDEEL

TIMMEREN

## DAKEN EN KAPCONSTRUCTIES VAN HOUT



# KEUZEDEEL

TIMMEREN/ METSELEN

# SCHOONMETSELWERK



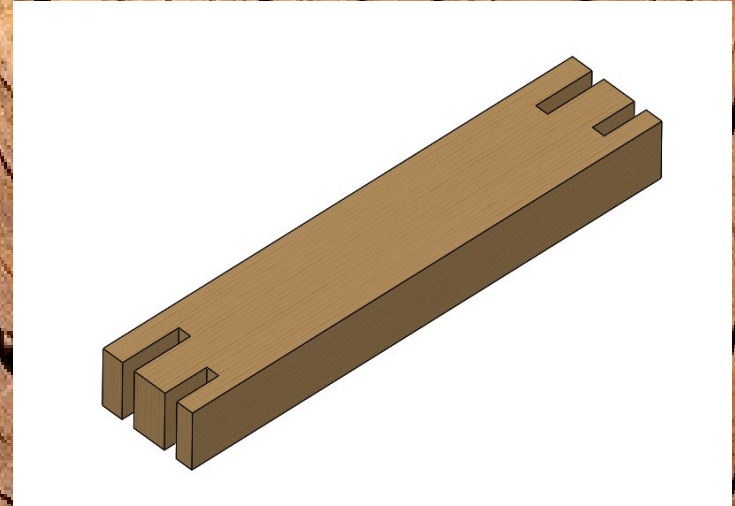

# KEUZEDEEL

TIMMEREN

# GEVELOPENINGEN

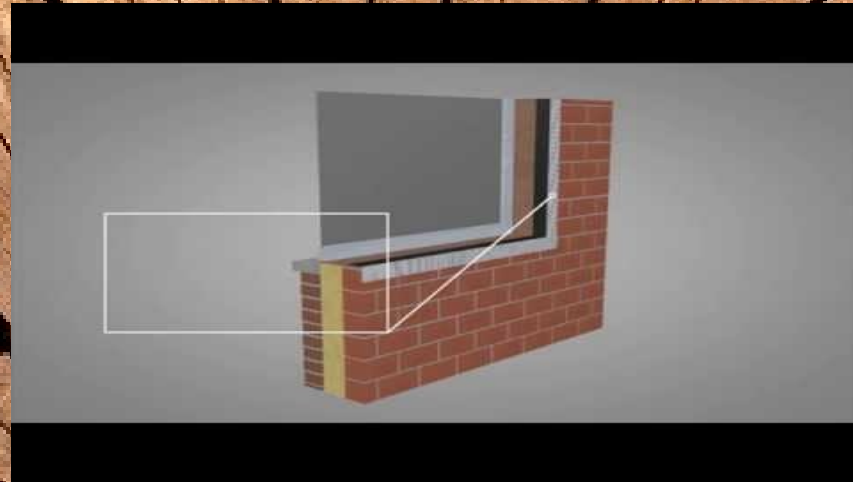

# KEUZEDEEL

TIMMEREN

## CONSTRUCTIEVE AANSLUITINGEN EN AFWERKING





# KEUZEDEEL

AFWERKINGSTECHNIEKEN

SCHILDEREN EN AFWERKEN VAN HOUT EN  
STEENACHTIGE ONDERGRONDEN

**KEUZEDEEL**

AFWERKINGSTECHNIEKEN

**ONDERHOUD SCHILDERWERK**







# KEUZEDEEL

AFWERKINGSTECHNIEKEN

SCHILDEREN EN SPUITEN OP KUNSTSTOF  
EN METALEN

# VRAGEN?

- [www.vernieuwingvmbo.nl](http://www.vernieuwingvmbo.nl)
- [r.kouwenberg@bhc.nl](mailto:r.kouwenberg@bhc.nl)

**BOUWEN**  
**WONEN**  
INTERIEUR